

# PUMP COVER PLATES

## OLDSMOBILE 425 & 455 PUMP COVER PLATE

### CAST ALUMINUM

Polished water pump cover plate. Ideal for jet installations. Furnished with bolts.

Catalog No.	Item No.
27620	691



## FORD 429 & 460 PUMP COVER PLATE

### CAST ALUMINUM

Polished water pump cover plate. Ideal for jet installations. Furnished with bolts.

Catalog No.	Item No.
27820	693

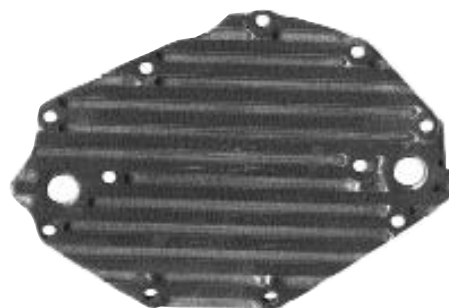

## OLDSMOBILE 425 & 455 CAM DRIVEN WATER PUMP COVER PLATE

### CAST ALUMINUM

Pump cover plate is made to use with stock steel timing chain cover. Furnished with cam drive and bolts.

Catalog No.	Item No.
27685	1665

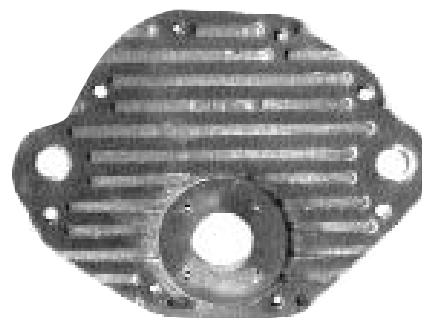

## FORD 429 & 460 CAM DRIVEN WATER PUMP COVER PLATE

### CAST ALUMINUM

Pump cover plate is made to use with stock aluminum timing chain cover. Furnished with cam drive and bolts.

Catalog No.	Item No.
27885	1675

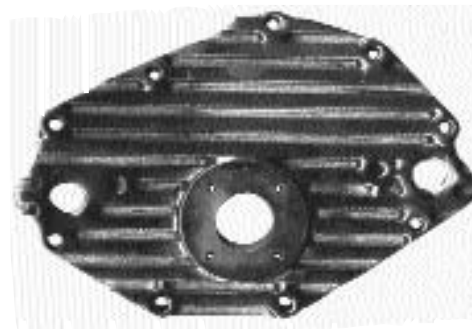

# COVER PLATES

## WATER COVER PLATES

CAST ALUMINUM AND POLISHED  
SOLD BY THE PAIR

CHEVROLET  
265, 283, 327  
and 350

Catalog No.	Item No.
27220	688



CHEVROLET  
396, 427 and 454

Catalog No.	Item No.
27720	692



FORD  
390, 406 and 427

Catalog No.	Item No.
27320	689

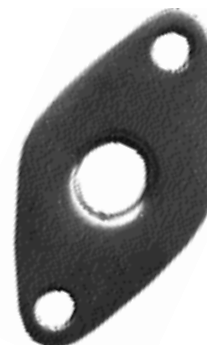

PONTIAC  
389 and 421

Catalog No.	Item No.
27420	690



# COVER PLATES • WATER DIVIDERS

## THERMOSTAT COVER PLATES

### CAST ALUMINUM

To block off thermostat opening in the intake manifold. Polished finish.

#### CHEVROLET

<b>Catalog No.</b>	<b>Item No.</b>
27027	1263

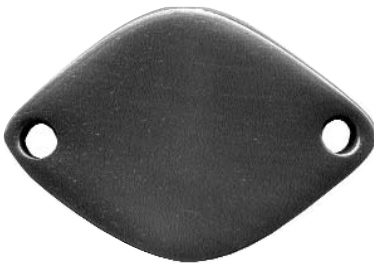

#### FORD - 429-460

<b>Catalog No.</b>	<b>Item No.</b>
27026	686

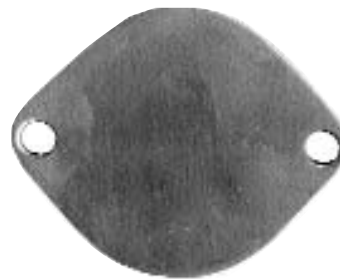

## WATER DISCHARGE DIVIDERS

### CAST ALUMINUM



Ford 332-352-390-406-427 & 428 cu. in.  
Polished aluminum alloy. Provides for equal discharge of water and easy connection of water hoses.

<b>Catalog No.</b>	<b>Item No.</b>
27023	683

## WATER DISCHARGE DIVIDERS

### CAST ALUMINUM



Allows water lines to be connected to water cooled exhaust manifolds or elbows with equal discharge rate.

	<b>Catalog No.</b>	<b>Item No.</b>
Chevrolet	27022	682
Oldsmobile	27024	684
Pontiac	27025	685

# WATER PUMPS • IMPELLERS

## MAGNAFLOW® CAM DRIVEN WATER PUMPS

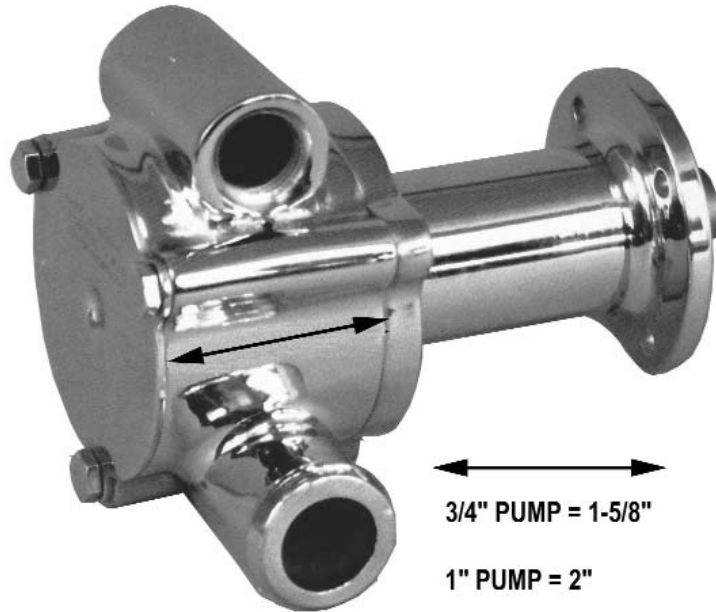

The "Magnaflows®" are self-priming, cam driven water pumps featuring chrome brass construction, friction minimizing ball bearings, long lasting ceramic seals and a tough neoprene impeller. To accommodate a variety of engine types, both "Magnaflow®" pumps come standard with a large 1 1/4" hose inlet, tapped 3/4" NPT and a pair of 1/2" NPT outlets.

### 1" MAGNAFLOW® WATER PUMP

	Catalog No.	Item No.
Pump	60000	1000
Impeller Kit*	60001	1001 (8 vanes)

### 3/4" MAGNAFLOW® WATER PUMP

	Catalog No.	Item No.
Pump	60034	1009
Impeller Kit*	60034	1010 (12 vanes)

\*Kits include 1 impeller and 2 "O" Rings.

### "NEOVANE" IMPELLER KITS

Kits include impeller, shear pin and gasket or "O" ring. Kits available for all models listed below.

#### Repair Kit

Item No.	For "Neovane" Pump No.
1018	V-505, V-755, H500 and V-750
1017	V-105

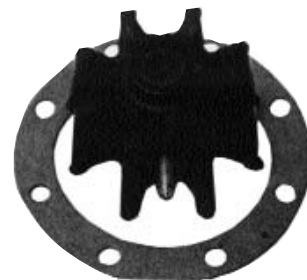

# WATER PUMPS • BILGE PUMPS

## Jabsco Water Pump

<b>Port Size</b> 3/4"	<b>Pump Model Catalog No.</b> 58500001	<b>Item No.</b> 1036	
<b>Impeller Catalog No.</b> 12100001	<b>Item No.</b> 1058	<b>Repair Kit No.</b> 900330001	

## Jabsco Water Pump

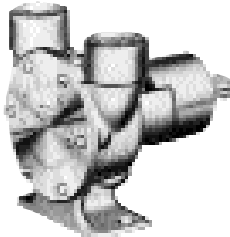
<b>Port Size</b> 1"	<b>Pump Model Catalog No.</b> 53309001	<b>Item No.</b> 1035	
<b>Impeller Catalog No.</b> 12100001 (3/4") 9200001 (1")	<b>Item No.</b> 1058 1057	<b>Repair Kit No.</b> 901110011 (3/4") 901180001 (1")	

## Jabsco Water Pump

<b>Port Size</b> 1"	<b>Pump Model Catalog No.</b> 7779001	<b>Item No.</b> 1024	
<b>1" High Speed</b>	<b>7779051</b>	<b>1025</b>	
<b>Impeller Catalog No.</b> 9200001	<b>Item No.</b> 1057	<b>Repair Kit No.</b> 901180001	<b>Item No.</b> 1054

## JABSCO SUBMURGIBLE BILGE PUMP

<b>Pump Model Catalog No.</b> 302202012	<b>Item No.</b> 1044
--	-------------------------



## AUTOMATIC FLOAT SWITCH

<b>Catalog No.</b> 302950000	<b>Item No.</b> 1041
---------------------------------	-------------------------



## JABSCO BILGE FOR BAIT TANK PUMP



<b>Volt D.C.</b> 12	<b>Pump Model Catalog No.</b> 18660-0121	<b>Item No.</b> 1038
<b>Impeller Catalog No.</b> 63030003	<b>Item No.</b> 1062	<b>Repair Kit No.</b> 900610003
		<b>Item No.</b> 1052

# WATER PICK-UPS

## MINIATURE WATER PICK-UP

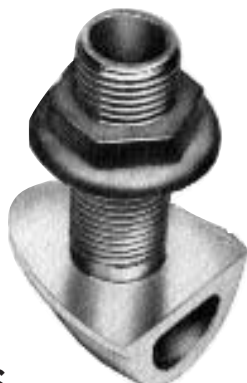

### CAST BRASS

A small streamline fitting which may be used with centrifugal feed cooling to the V-Drive.

**Pipe I.D.:** 3/8"

**Pipe Length:** 1-5/8"

Description	Catalog No.	Item No.
Brass	19731	406
Chrome	19741	408

## HIGH SPEED SCOOP STRAINERS

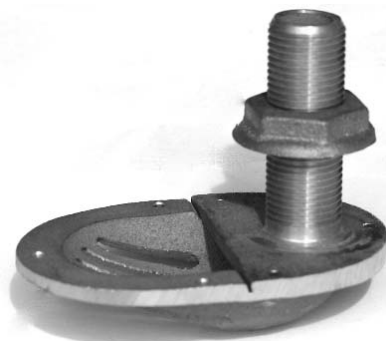

### CAST BRASS

Water inlet fitting has a protective grate over the intake.

Pipe I.D.	Pipe Length	Catalog No.	Item No.
1/2"	2-1/4"	30112	729
3/4"	2-9/16"	30134	730
1"	3"	30101	728

## HIGH SPEED WATER PICK-UP



### CAST BRASS

A pick-up which can be used with a pump or centrifugal feeding the block.

**Pipe I.D.:** 1/2"

**Pipe Length:** 2-1/4"

Description	Catalog No.	Item No.
Brass	30230	731
Chrome	30240	732

## WATER DIVIDER TEE



### CAST BRASS

This water divider is a must on V-8 engines to distribute an even flow of water to both cylinder heads. The inlet is tapped for 1/2" NPT and the outlets are for 5/8" hose.

Description	Catalog No.	Item No.
Brass	21130	465
Chrome	21140	466

# PICKUP KITS • HOSE

## CAVITATION PLATE PICKUP KIT

### STAINLESS STEEL

This stainless steel cavitation plate pickup is used to take water from the cavitation plates to the engine.

Description	Catalog No.	Item No.
Kit complete (less hose)	22350	537
Pickup only	22351	538
Thru Hull only	22352	539



## BRAIDED HOSE

### STAINLESS STEEL



This hose is made of synthetic rubber with stainless steel wire braid covering it. Complete with stainless steel straight, swivel nuts, 5/8" #10, to fit our Item #537 Cavitation Plate Pickup Kit.

Description	Catalog No.	Item No.
12" of braided hose and the fittings	22201	534

## NEOPRENE HIGH PRESSURE HOSE AND FITTINGS



Used for oil and transmission lines. This hose has an average working pressure of 250 lbs. PSI and has an average burst pressure of 1,000 lbs. PSI per foot.

### Fitting Only

I.D. Hose	Catalog No.	Item No.
1/4"	23614	616
3/8"	23638	618
1/2"	23612	615
5/8"	23658	619
3/4"	23634	617

## WATER HOSE



Water hose for connecting water supply on engine conversions.

I.D. Hose	O.D. Hose	Catalog No.	Item No.
5/8"	1"	15958	206
3/4"	1-1/8"	15934	205
1"	1-3/8"	15901	203

### Hose Only

I.D. Hose	Catalog No.	Item No.
1/4"	22914	596
3/8"	22938	598
1/2"	22912	595
5/8"	22958	599
3/4"	22934	597